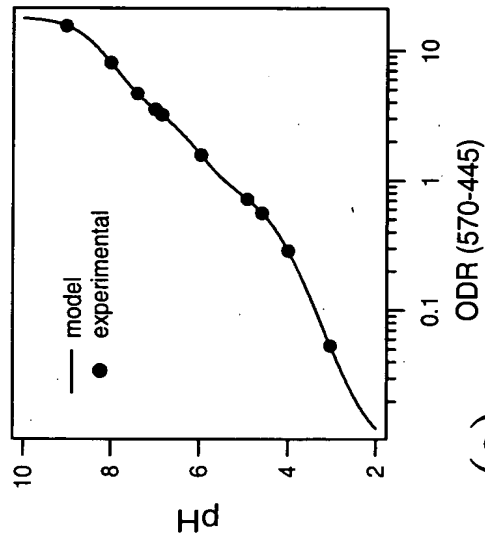
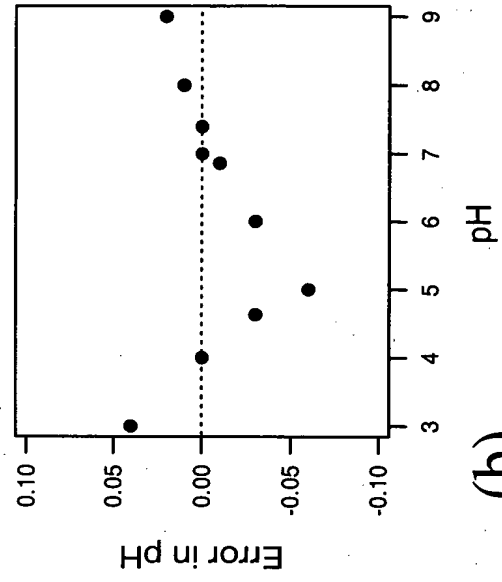

Figure 1



(a)



(b)

Figure 2

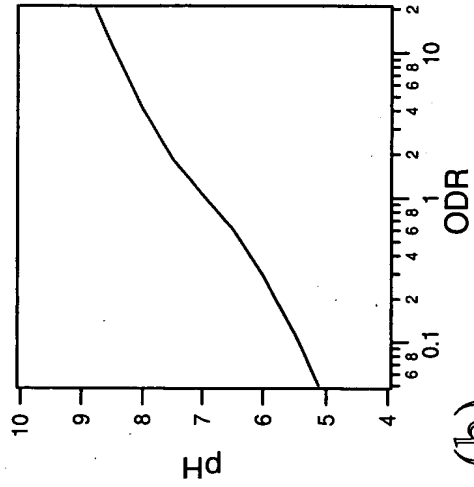

(a)

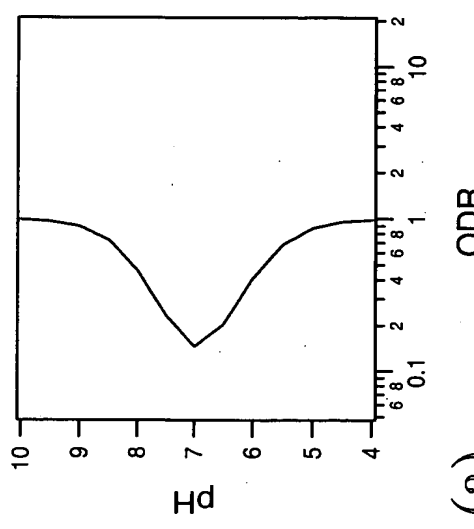

(b)

Figure 3

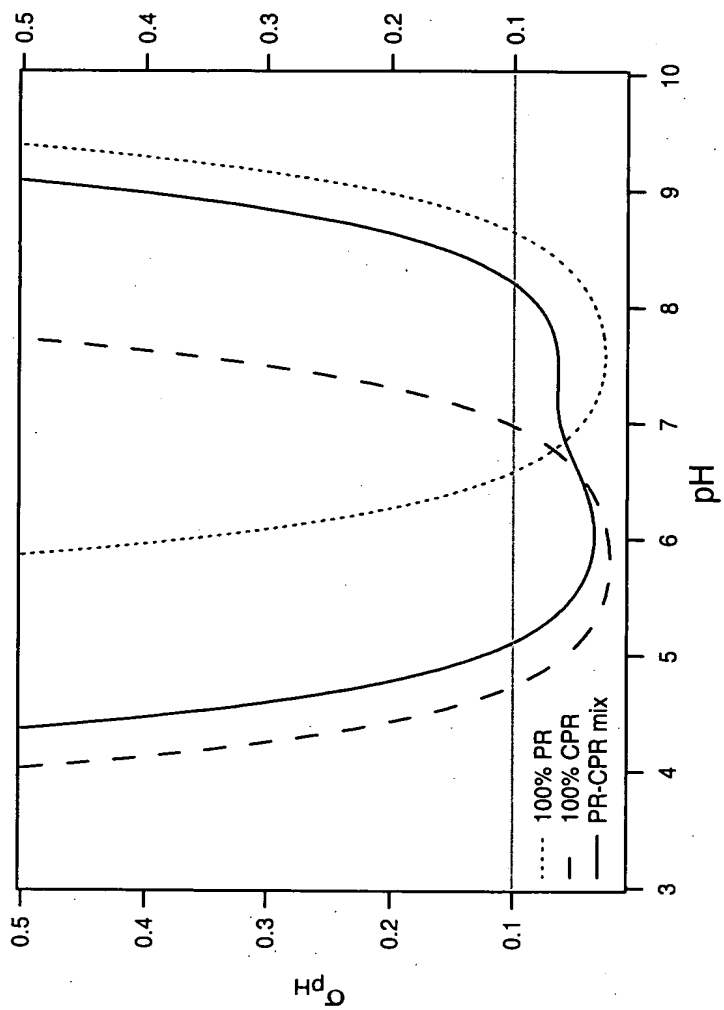

Figure 4

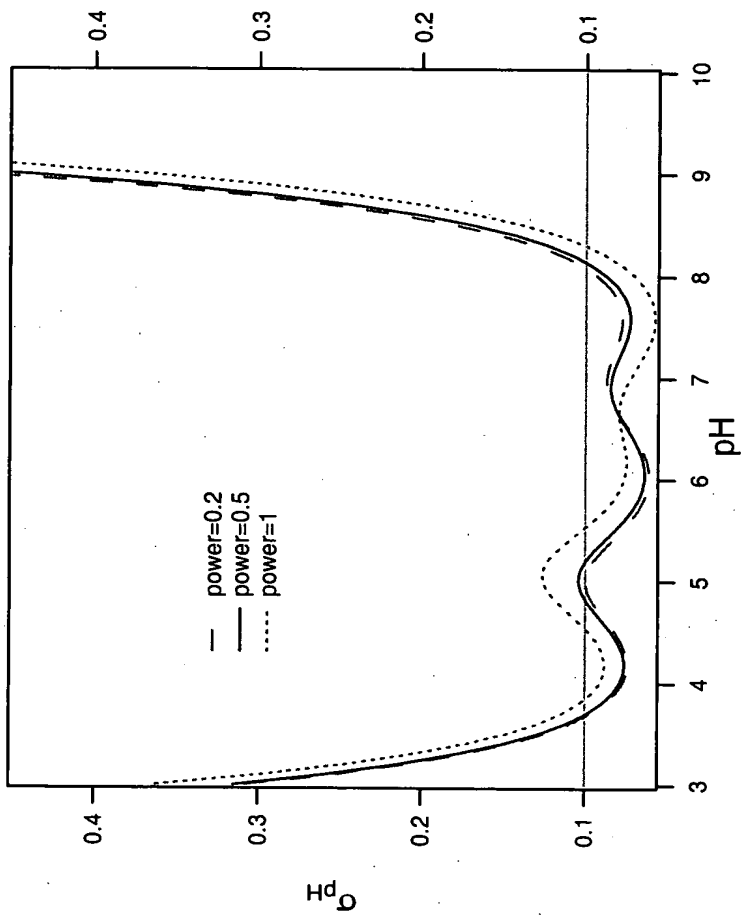

Figure 5

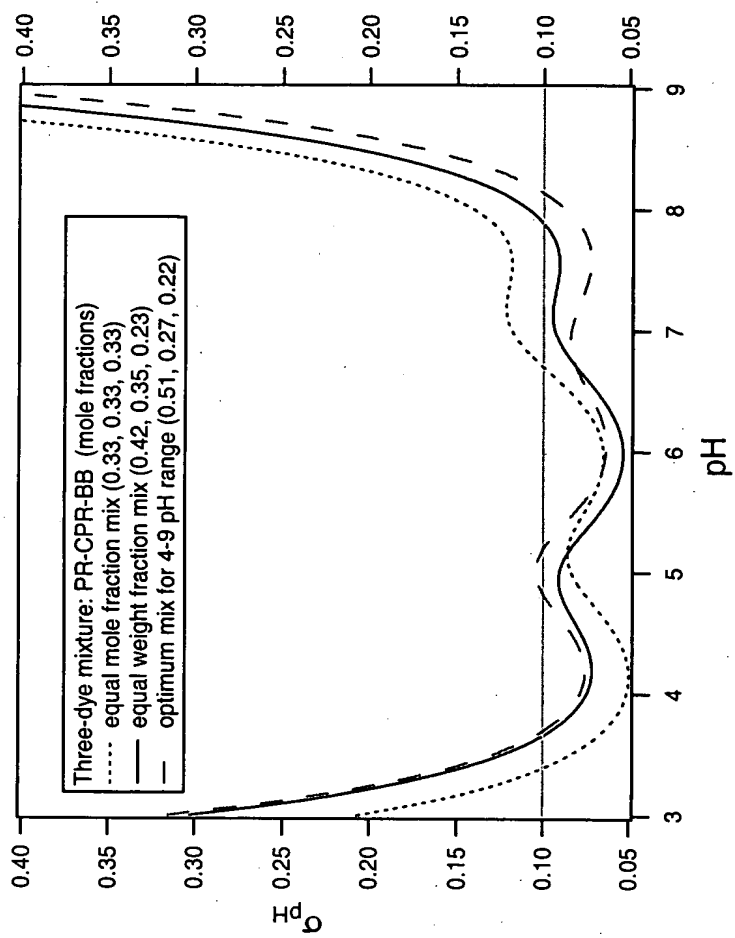

Figure 6

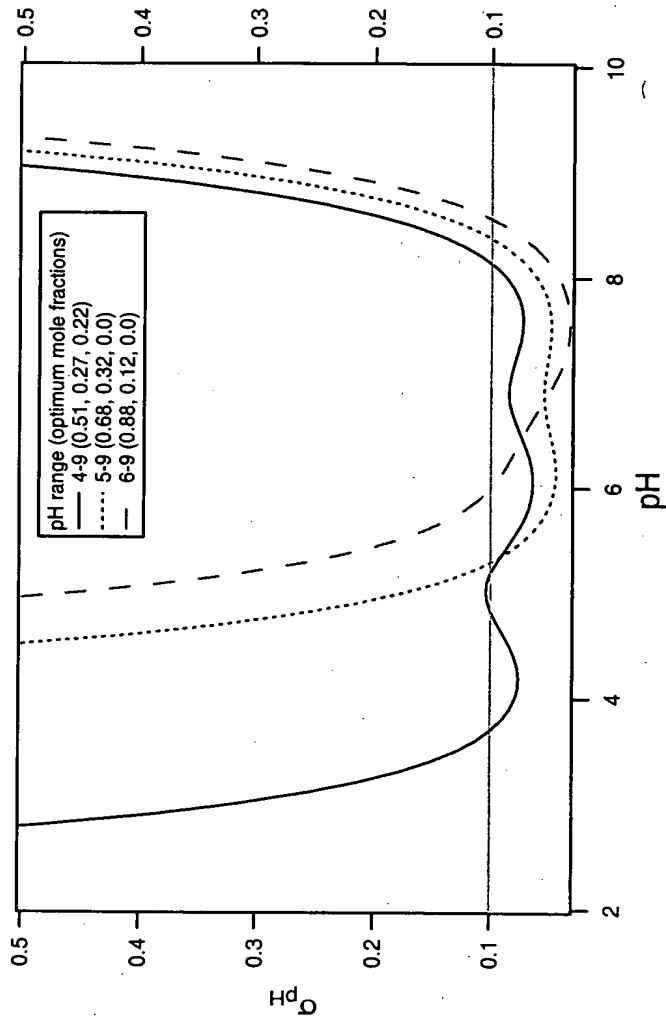

Figure 7

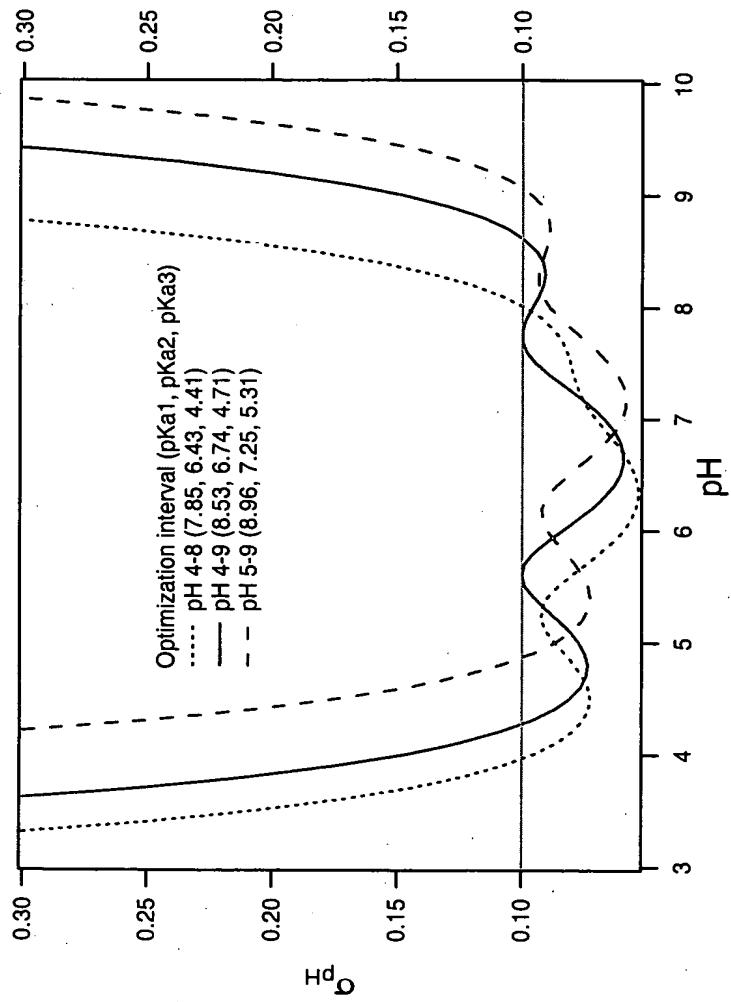

Figure 8



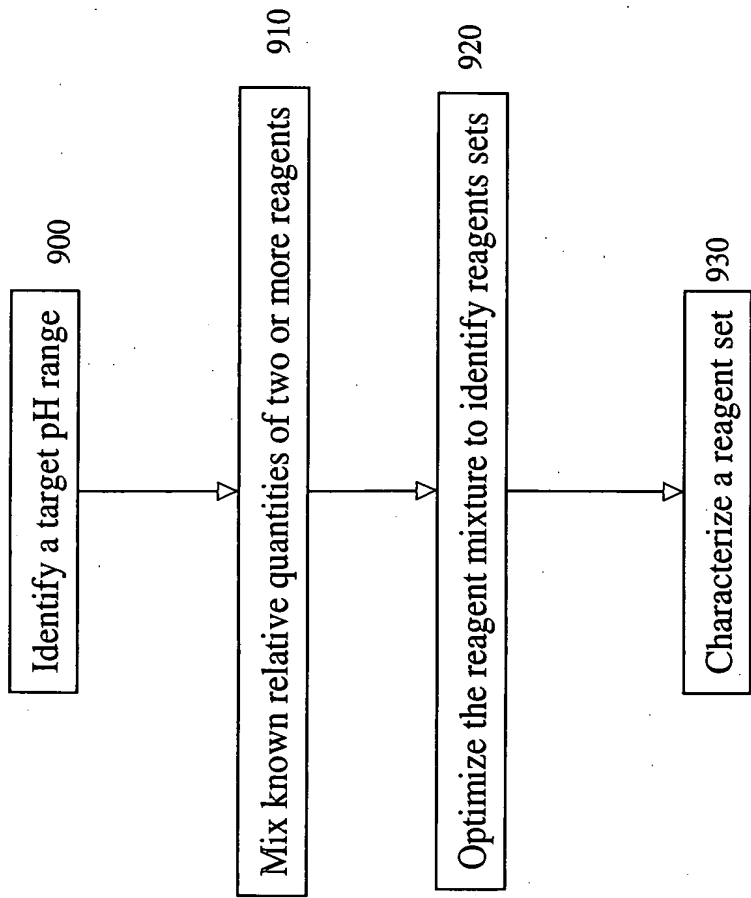

Figure 9(a)

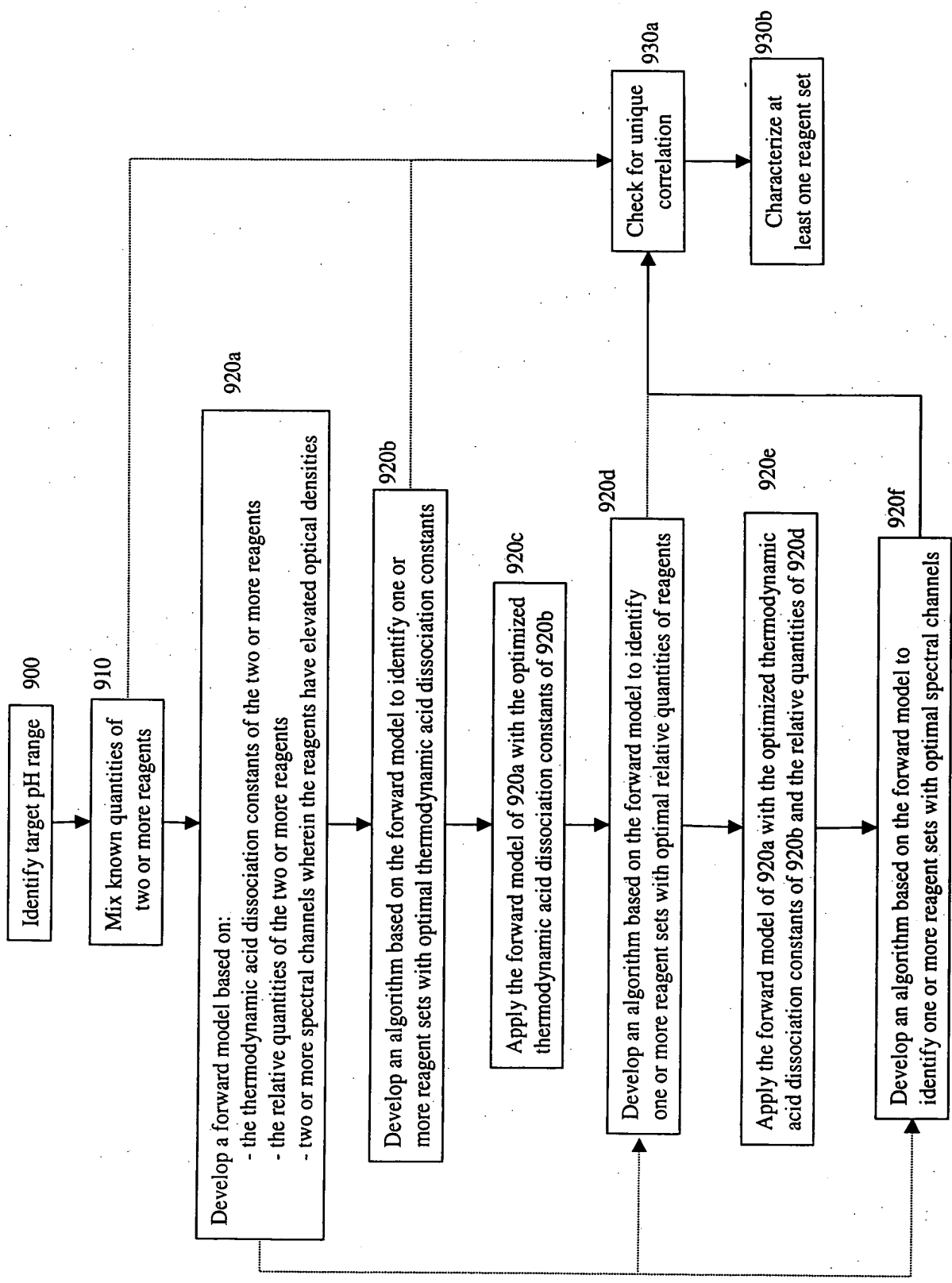

Figure 9(b)

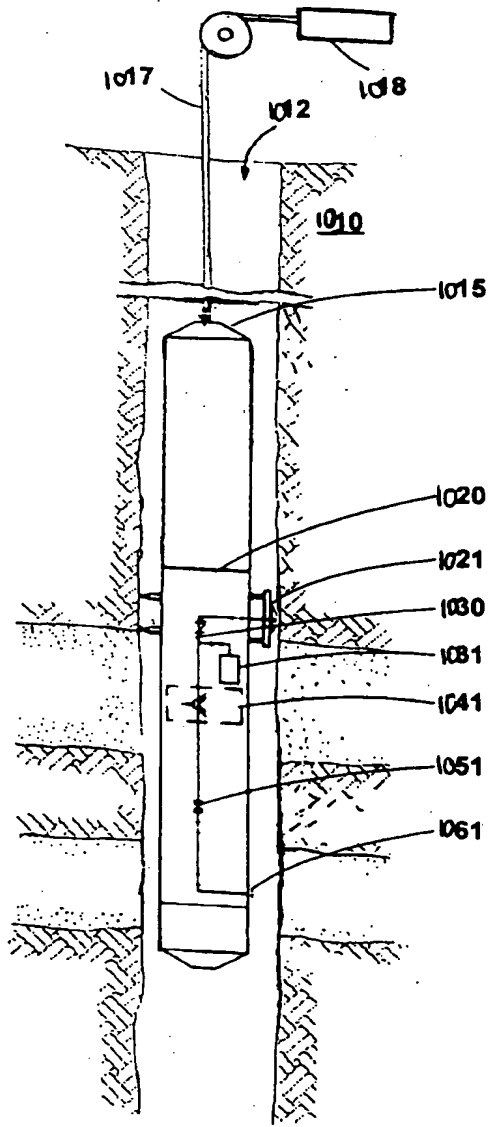

FIGURE 10